

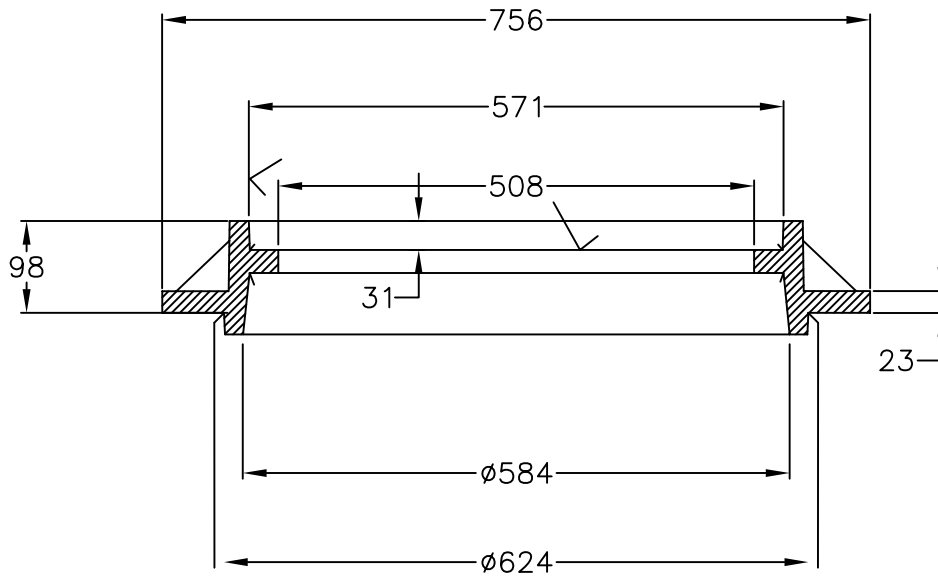

PLAN



SECTION A-A

APPROX. WEIGHT
FRAME - 68KG

 DOBNEY FOUNDRY LTD. SURREY B.C.	
RATING-HWY LOAD	
MANHOLE FRAME	NO. C-20LP